



TECHNICAL SPECIFICATION

INPUT SPECIFICATION :

Direct Current AC	0.1Amp to 5 Amp AC
Primary CT	5 to 9999 Amp (Selectable)
Secondary CT	5 or 1 Amp (Selectable)
Accuracy	Class 0.5

DISPLAY AND KEY :

Display	4 digit, 1line, 7 seg, 0.56" RED LED
Keys	SET/ENT, INC, DEC
LED Indication	L1, L2, L3, Avg

Dimension :

Dimension (mm)	72 (H) x 72 (W) x 45 (D) mm
Panel Cutout	68 (H) x 68 (W) mm

ACCURACY

Class 0.5 (Standard)

AUXILIARY SUPPLY :

Supply voltage	100-270V AC 50/60HZ 3VA
Power consumption (VA RATING)	3 VA

ENVIRONMENT CONDITION :

Operating Temp.	0°C to 55°C
Relative Humidity	UP to 95% RH (non-condensing)
Protection Level (As per request)	IP-65 (Front side) As per IS/IEC 60529 : 2001

MECHANICAL INSTALLATION

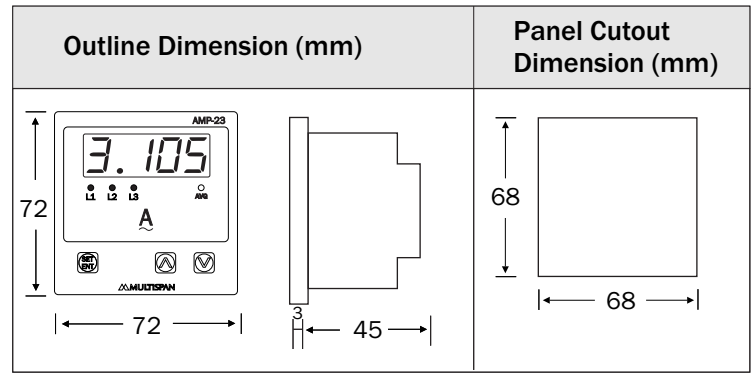

TERMINAL CONNECTION

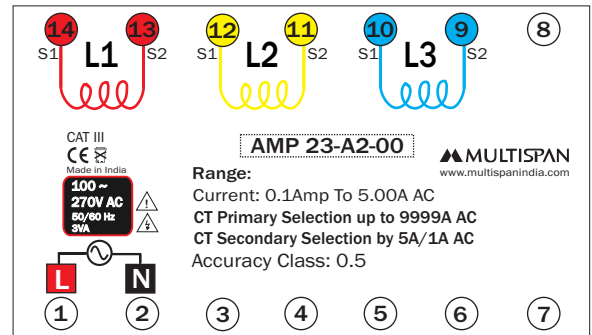

DISPLAY PAGE

1) L1 Current

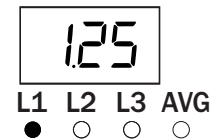

2) L2 Current

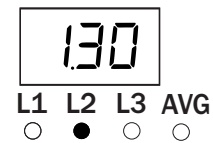



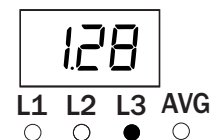



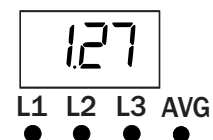

3) L3 Current



4) Average Current



KEY OPERATION

FUNCTION	PRESS KEY
OPERATOR MODE	
To enter in parameter setting	 For 5 sec
To view individual phase Current	 OR 
To Scroll & Hold Page	 +  For 5 sec
PARAMETER SETTING MODE	
It is used to set parameter value and to be save & exit from menu	
To increment value in parameter setting	
To decrement value in parameter setting	

MECHANICAL INSTALLATION

1. Prepare the panel cutout with proper dimensions as shown above.
2. Fit the unit into the panel with the help of clamp given.
3. The equipment in its installed state must not come in close proximity to any heating source, caustic vapors, oil steam, or other unwanted process byproducts.
4. Use the specified size of crimp terminal (M3.5 screws) to wire the terminal block. Tightening the screws on the terminal block using the tightening torque of the range of 1.2 N.m.
5. Do not connect anything to unused terminals.

INSTALLATION GUIDELINES

- 1) Do not allow pieces of metal, wire clippings, or fine metallic fillings from installation to enter the product or else it may lead to a safety hazard that may in turn endanger life or cause electrical shock to the operator.
- 2) Circuit breaker or mains switch must be installed between power source and supply terminal to facilitate power 'ON' or 'OFF' function. However this mains switch or circuit breaker must be installed at convenient place normally accessible to the operator.
- 3) Use and store the instrument within the specified ambient temperature and humidity ranges as mentioned in this manual.

SAFETY PRECAUTION

All safety related codifications, symbols and instructions that appear in this operating manual or on the equipment must be strictly followed to ensure the safety of the operating personnel as well as the instrument.

If all the equipment is not handled in a manner specified by the manufacturer, it might impair the protection provided by the equipment.



Read complete instructions prior to installation and operation of the unit.



WARNING : Risk of electric shock.

WARNING GUIDELINES



WARNING : Risk of electric shock.

- 1) To prevent the risk of electric shock, power supply to the equipment must be kept OFF while doing the wiring arrangement. Do not touch the terminals while power is being supplied.
- 2) To reduce electro magnetic interference, use wire with adequate rating and twists of the same of equal size shall be made with shortest connection.
3. Cable used for connection to power source, must have a cross section of 1mm or greater. These wires should have insulations capacity made of at least 1.5kV.
- 4) A better anti-noise effect can be expected by using standard power supply cable for the instrument.

MAINTENANCE

- 1) The equipment should be cleaned regularly to avoid blockage of ventilating parts.
- 2) Clean the equipment with a clean soft cloth. Do not use isopropyl alcohol or any other cleaning agent.
- 3) Fusible resistor must not be replaced by operator.

PARAMETER SETTING

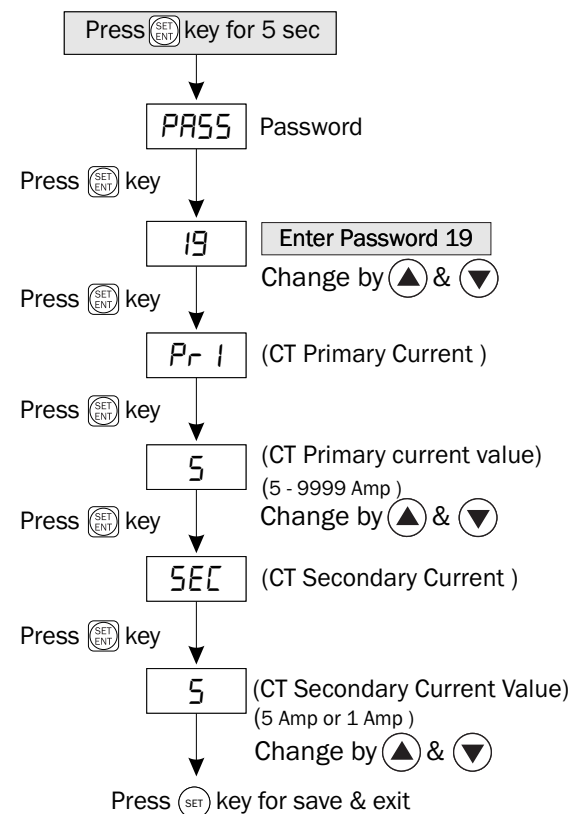

Specifications are subject to change, since development is a continuous process, So for more updated operating information and Support, Please contact our Helpline: +91-9081078683/81 or Email at service@multispanindia.com Ver:2301